

2024

FLEX BENCH
SMART WORKSPACE ERGONOMICS



Products Brochure

Ergonomic Intelligence Height Adjustable Solution Provider

I. Desk Frame

II. Lifting Column

III. Control Box

IV. Controls

V. Accessories



Exquisiteness



High-performance motor
Smooth and stable movement,
Faster speed and stronger load-bearing.

Height adjustable desk frame
Height range: 600-1250mm
Suitable for people with different height.

Strict performance and aging test
ensure the satisfactory experience
in daily use.



Strength

The new control program developed by
FLEX BENCH has been adopted in the
controls, which optimizes anti-collision,
current protection and short circuit protec-
tion.

Flexibility



In some international top enterprises,
height adjustable desk is becoming the
standard office supplies.



At home, the table could fit each
member's height, so as to meet a
whole family's needs.



In the professional E-sport field,
the height adjustable desk could
help the player maintain the best form.

Multiple colors

We provide color customization for lifting
column products.
Unlimited colors satisfy the designers'
unlimited creativity.



Certification

FLEX BENCH ergonomic products have
obtained a number of international
certifications.



DF01N



Features

- High strength carbon steel
- 2 / 3 stage lifting columns
- Laser cutting / welding
- Dual motor
- Soft start / stop
- Wired / wireless control

Specification

625 -1275 mm

Height Range

40 mm /s

Speed

650 mm

Max. Stroke

≤ 50 dB

Noise

1100 - 1700 mm

Width Range



White
RAL9003Y



Silver
RAL7038

1200N

Max. Load



Black
RAL9005A

Measurement(mm)

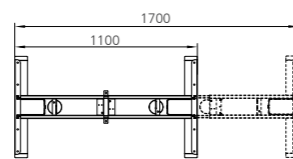
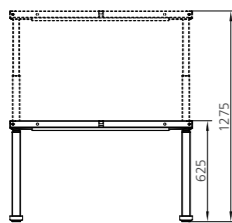

DF01S Max



Features

- High strength carbon steel
- 3-Stage
- Laser cutting / welding
- Dual motor
- Soft start / stop
- Wired / wireless control

Specification

660 -1310 mm

Height Range

22 mm /s

Speed

650 mm

Max. Stroke

≤ 50 dB

Noise

1640 - 2100 mm

Width Range



White
RAL9003Y



Silver
RAL7038

2000N

Max. Load



Black
RAL9005A

Measurement(mm)

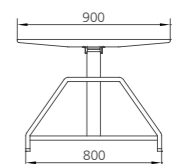
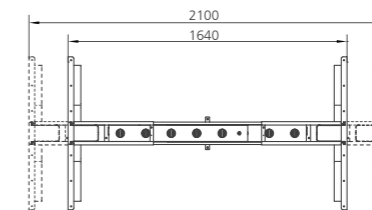
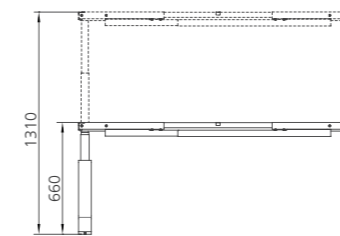

DF02N



Features

- High strength carbon steel
- 2 / 3 stage lifting columns
- Laser cutting / welding
- Triple motor
- Soft start / stop
- Wired / wireless control

Specification

625-1275 mm

Height Range

40 mm / s

Speed

650 mm

Max. Stroke

≤ 50 dB

Noise

1920-2900 mm

Width Range

White
RAL9003Y

Silver
RAL7038

1500N

Max. Load

Black
RAL9005A

Measurement(mm)

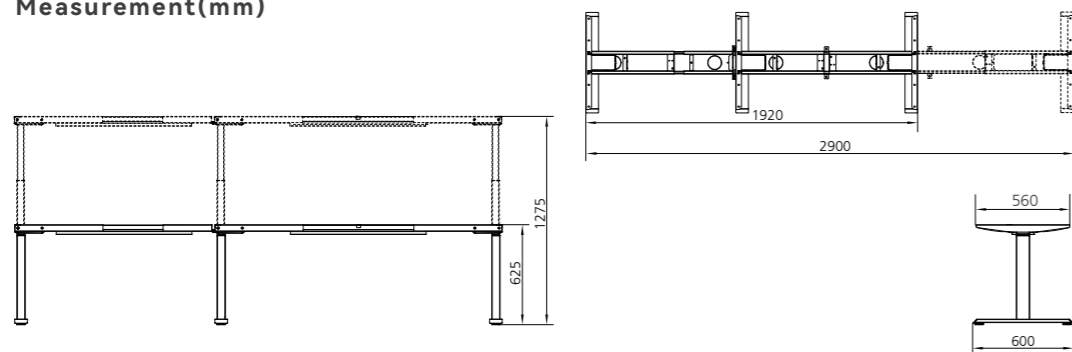

DF03N



Features

- High strength carbon steel
- 2 / 3 stage lifting columns
- Laser cutting / welding
- Triple motor
- Soft start / stop
- Wired / wireless control

Specification

625-1275 mm

Height Range

40 mm / s

Speed

650 mm

Max. Stroke

≤ 50 dB

Noise

1100-1700 mm (Main)
820-1200 mm (Side)

Width Range

White
RAL9003Y

Silver
RAL7038

1500N

Max. Load

Black
RAL9005A

Measurement(mm)

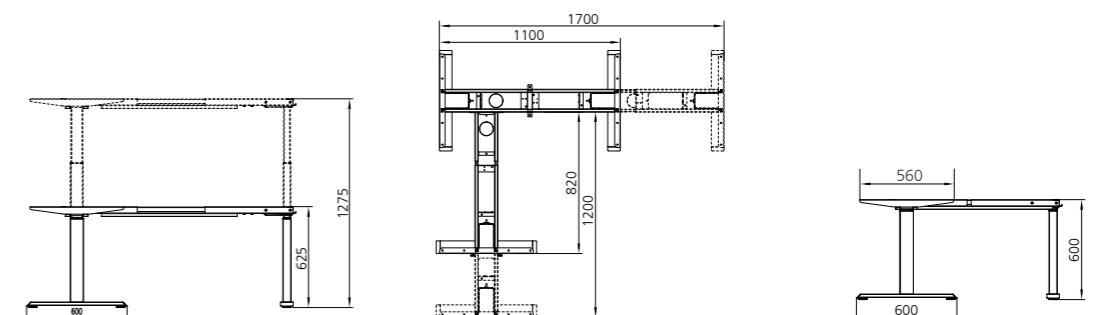

DF03P



Features

- High strength carbon steel
- Triple motor
- 2 / 3 stage lifting columns
- Soft start / stop
- Laser cutting / welding
- Wired / wireless control

Specification

625 - 1275 mm

Height Range

40 mm / s

Speed

650 mm

Max. Stroke

≤ 50 dB

Noise

1230 - 1810mm

Width Range

White
RAL9003Y

Silver
RAL7038

1500N

Max. Load

Black
RAL9005A

Measurement(mm)

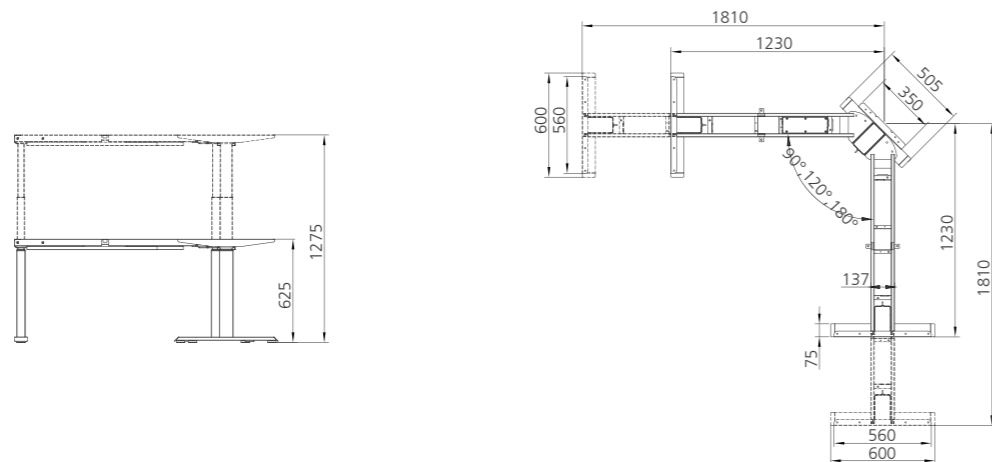

DF04N



Features

- High strength carbon steel
- Dual motor
- 2 / 3 stage lifting columns
- Soft start / stop
- Laser cutting / welding
- Wired / wireless control

Specification

625 - 1275 mm

Height Range

40 mm / s

Speed

650 mm

Max. Stroke

≤ 50 dB

Noise

1100 - 1700 mm

Width Range

White
RAL9003Y

Silver
RAL7038

1200N

Max. Load

Black
RAL9005A

Measurement(mm)

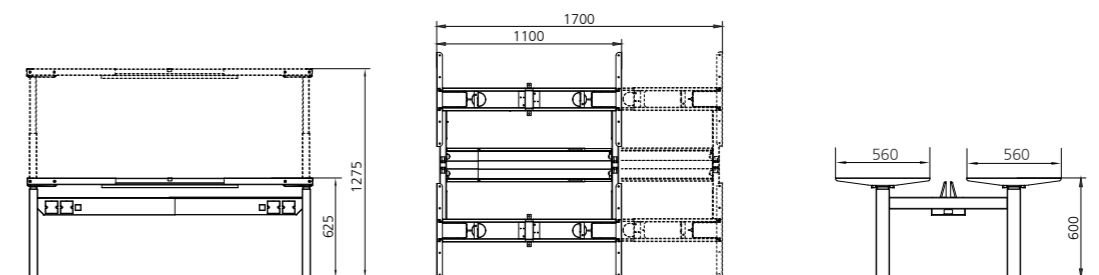

DF011



Features

- High strength carbon steel
- 2-Stage
- Laser cutting / welding
- Single motor
- Soft start / stop
- Wired / wireless control

Specification

690 - 1150 mm

Height Range

25 mm / s

Speed

460 mm

Max. Stroke

≤ 50 dB

Noise

880 - 1300 mm

Width Range



White
RAL9003Y



Silver
RAL7038

800N

Max. Load



Black
RAL9005A

Measurement(mm)

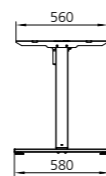
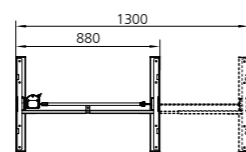
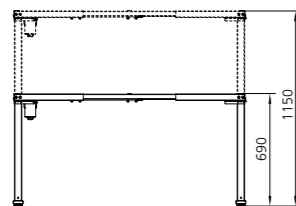

DF12T



Features

- High strength carbon steel
- 2 / 3 stage lifting columns
- Laser cutting / welding
- Single motor
- Soft start / stop
- Wired / wireless control

Specification

706 - 1206 mm

Height Range

≤ 50 dB

Noise

500 mm

Max. Stroke

32 mm / s

Speed



White
RAL9003Y



Silver
RAL7038

300N

Max. Load



Black
RAL9005A

Measurement(mm)

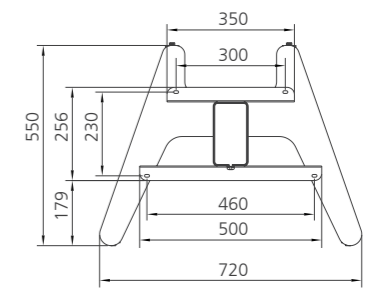
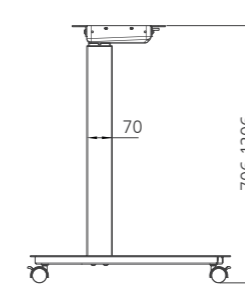
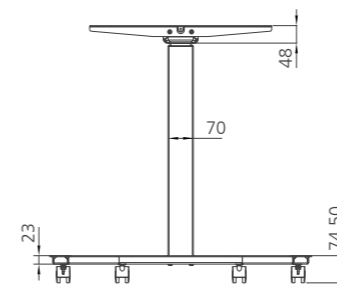

DF013



Features

- High strength aluminium alloy
- 2-Stage
- Laser cutting / welding
- Dual motor
- Soft start / stop
- Wired / wireless control

Specification

660 -1060 mm

Height Range

400 mm

Max. Stroke

1270 - 2060 mm

Width Range

4000N

Max. Load

4 - 16 mm /s

Speed

≤ 50 dB

Noise

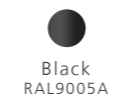

Measurement(mm)

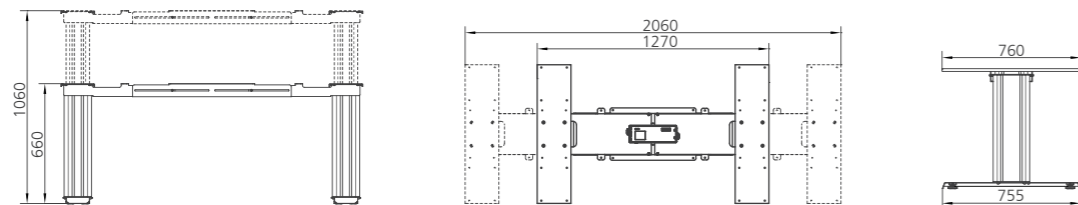

DF015



Features

- High strength carbon steel
- 2 / 3 stage lifting columns
- Laser cutting / welding
- Single motor
- Soft start / stop
- Wired / wireless control

Specification

700 -1200 mm

Height Range

500 mm

Max. Stroke

32 mm /s

Speed

300N

Max. Load

≤ 50 dB

Noise

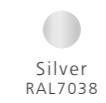
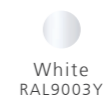

Measurement(mm)

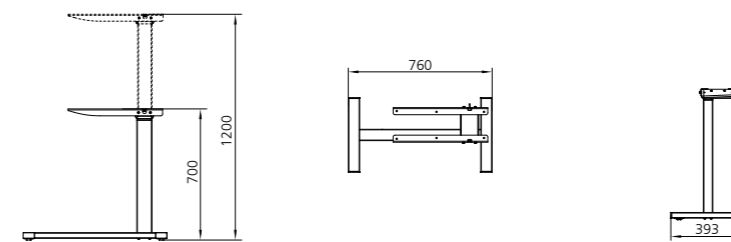



DF017N



Features

- High strength carbon steel
- 2 / 3 stage lifting columns
- Laser cutting / welding
- Triple motor
- Soft start / stop
- Wired / wireless control

Specification

625-1275 mm Height Range	650 mm Max. Stroke	1120 - 1670 mm Width Range	1500N Max. Load
40 mm /s Speed	≤ 50 dB Noise	<div style="display: flex; justify-content: space-around;"> <div style="text-align: center;">  White RAL9003Y </div> <div style="text-align: center;">  Silver RAL7038 </div> <div style="text-align: center;">  Black RAL9005A </div> </div>	

Measurement(mm)

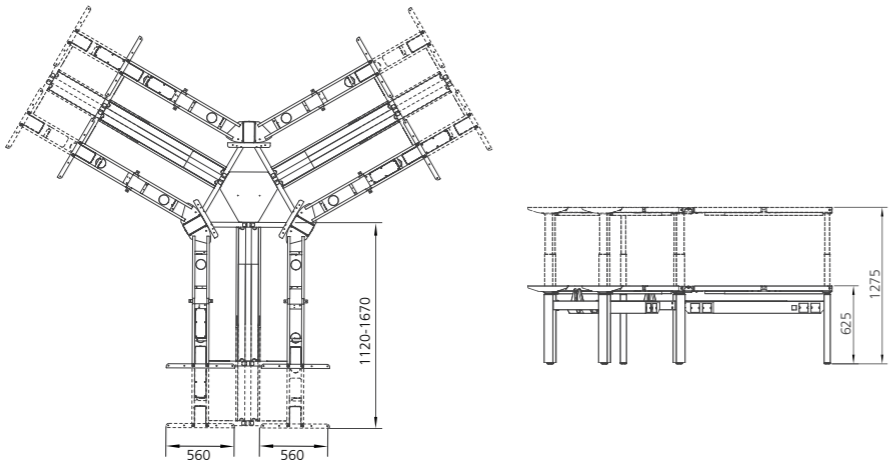

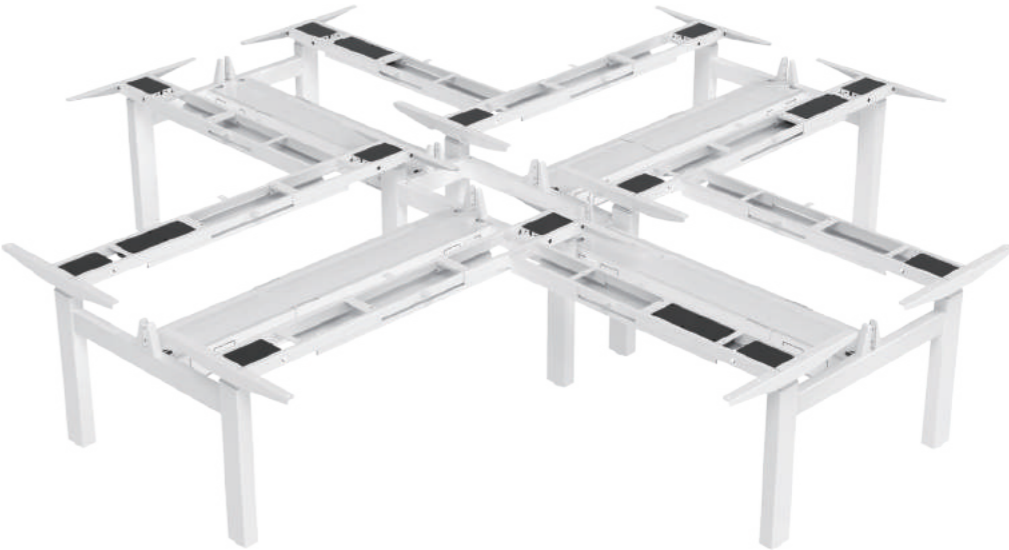

DF019N



Features

- High strength carbon steel
- 2 / 3 stage lifting columns
- Laser cutting / welding
- Triple motor
- Soft start / stop
- Wired / wireless control

Specification

625-1275 mm Height Range	650 mm Max. Stroke	1110- 1710 mm Width Range	1500N Max. Load
40 mm /s Speed	≤ 50 dB Noise	<div style="display: flex; justify-content: space-around;"> <div style="text-align: center;">  White RAL9003Y </div> <div style="text-align: center;">  Silver RAL7038 </div> <div style="text-align: center;">  Black RAL9005A </div> </div>	

Measurement(mm)

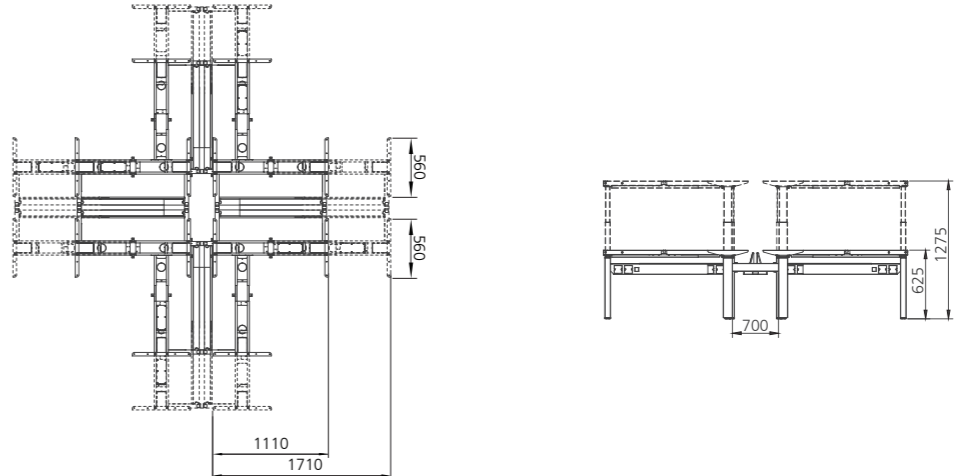

DF031



Features

- High strength carbon steel
- 2 / 3 stage lifting columns
- Laser cutting / welding
- Dual motor
- Soft start / stop
- Wired / wireless control

Specification

625 -1275 mm

Height Range

650 mm

Max. Stroke

600 * 1200 mm

Frame Size

1200N

Max. Load

40 mm /s

Speed

≤ 50 dB

Noise



White
RAL9003Y



Silver
RAL7038



Black
RAL9005A

Measurement(mm)

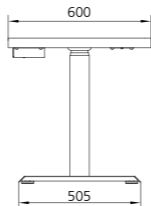
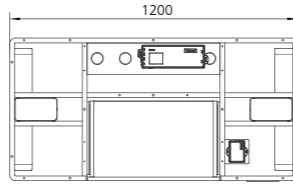
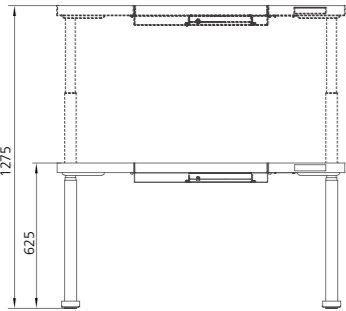

High-performance Lifting Columns

Based on different needs, we offer 2 / 3-stage lifting columns, featuring smooth movement, low noise and heavy load, which could perfectly fit multiple styles of desk frames.

L5E2



L5C2



L5R2



L5S2



Features

- 2-Stage
- High strength carbon steel
- Laser cutting / welding
- Hole-free columns
- Color customization

Specification

650 mm

Installation Size

500 mm

Max. Stroke

1150 mm

Max. Height

800N

Max. Load

32 mm /s

Speed

≤ 50 dB

Noise



White
RAL9003Y



Silver
RAL7038



Black
RAL9005A

Measurement(mm)

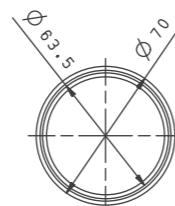
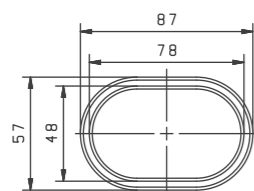
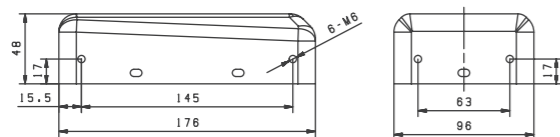

Features

- 2-Stage
- High strength carbon steel
- Laser cutting / welding
- Hole-free columns
- Color customization

Specification

650 mm

Installation Size

500 mm

Max. Stroke

1150 mm

Max. Height

800N

Max. Load

32 mm /s

Speed

≤ 50 dB

Noise



White
RAL9003Y



Silver
RAL7038



Black
RAL9005A

Measurement(mm)

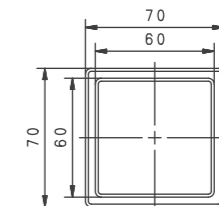
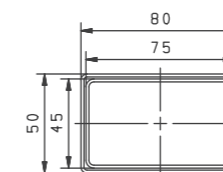
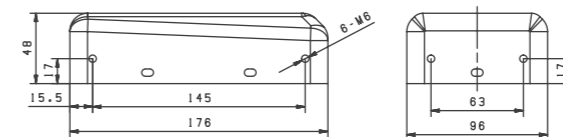

L5R2P

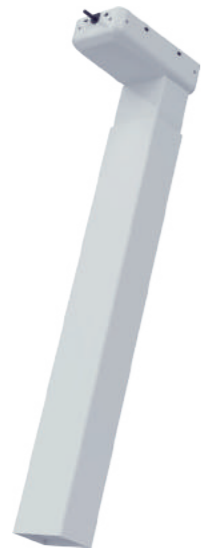

L5S2P

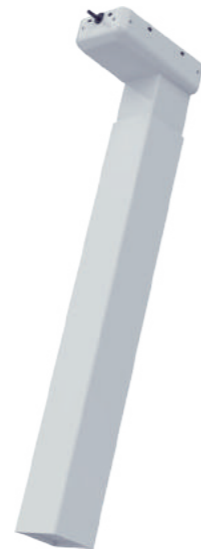

L6E2



L6C2



Features

- 2-Stage
- High strength carbon steel
- Laser cutting / welding
- Hole-free columns
- Color customization

Specification

650 mm

Installation Size

500 mm

Max. Stroke

1150 mm

Max. Height

800N

Max. Load

32 mm /s

Speed

≤ 50 dB

Noise



White
RAL9003Y



Silver
RAL7038



Black
RAL9005A

Features

- 3-Stage
- High strength carbon steel
- Laser cutting / welding
- Hole-free columns
- Color customization

Specification

585mm

Installation Size

650 mm

Max. Stroke

1235 mm

Max. Height

800N

Max. Load

40 mm /s

Speed

≤ 50 dB

Noise



White
RAL9003Y



Silver
RAL7038



Black
RAL9005A

Measurement(mm)

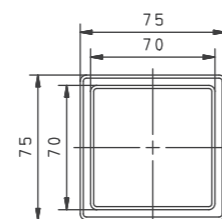
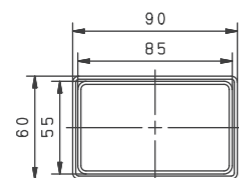
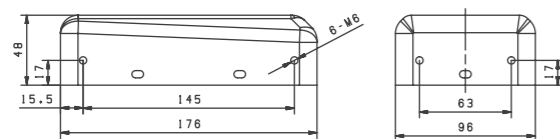

Measurement(mm)

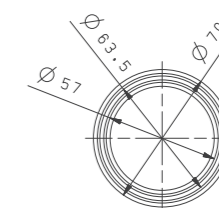
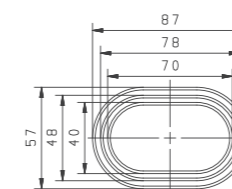
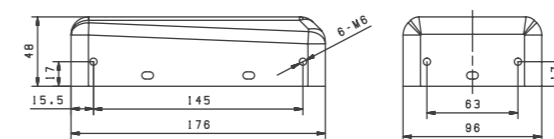

L6R2



L6S2



L6R2P



L6S2P

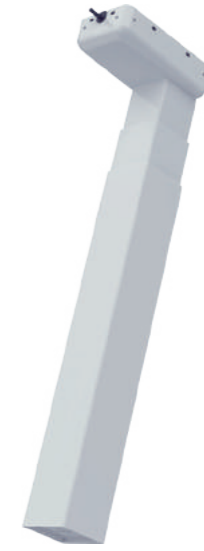

Features

- 3-Stage
- High strength carbon steel
- Laser cutting / welding
- Hole-free columns
- Color customization

Specification

585 mm

Installation Size

650mm

Max. Stroke

1235 mm

Max. Height

800N

Max. Load

40 mm /s

Speed

≤ 50 dB

Noise

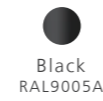
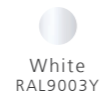

Measurement(mm)

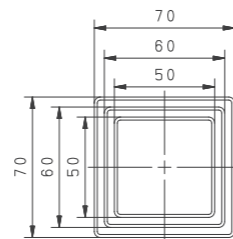
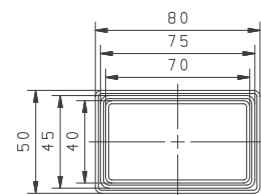
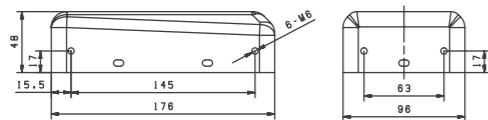

Features

- 3-Stage
- High strength carbon steel
- Laser cutting / welding
- Hole-free columns
- Color customization

Specification

585 mm

Installation Size

650mm

Max. Stroke

1235 mm

Max. Height

800N

Max. Load

40 mm /s

Speed

≤ 50 dB

Noise

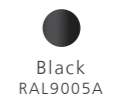
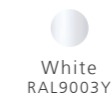

Measurement(mm)

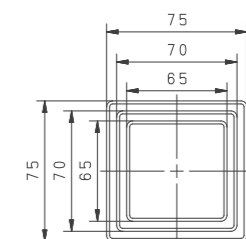
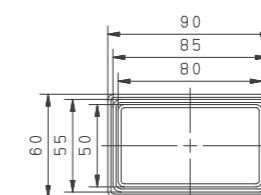
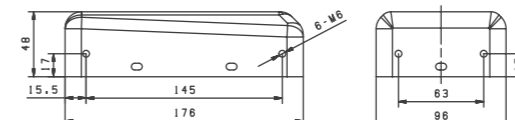



L6C2-20

- 681*77*52mm



DF01S-03M0

- 600*75*26mm



C31E

- Number of motors controllable: 1
- Rated Power: 100W
- Connectable to lithium Battery
- Overheat / Overload protection



C32E

- Number of motors controllable: 2
- Rated Power: 200W
- Connectable to lithium battery
- Overheat / Overload protection



DF01S-03P0

- 600*75*26mm



DF01N-03A0

- 600*75*20mm



C33E

- Number of motors controllable: 3
- Rated Power: 300W
- Connectable to lithium battery
- Overheat / Overload protection



C34

- Number of motors controllable: 4
- Rated Power: 600W
- Connectable to lithium battery
- Overheat / Overload protection



DF011-5500

- 580*60*20mm



C66

- Multi-function convertor
- Bluetooth
- Gyro-sensor
- Connectable to 2 controls



HL1

- 3 Memory position
- LED height display
- Lock



HL9

- Silicon button
- Small and compact design



HL22

- 4 Memory position
- LED height display
- Lock
- Type-A / C
- Built-in control



HL23

- 3 Memory position
- LED height display
- Lock
- Built-in control



HL13

- 4 Memory position
- Touch Screen
- LED height display
- Lock



HL15

- 4 Memory position
- LED height display
- Lock



HL29

- 3 Memory position
- LED height display
- Silicon button
- Lock



HL33

- 4 Memory position
- Sedentary alert
- LED height display
- Lock
- Type-A / C



HL17U

- 4 Memory position
- LED height display
- Lock
- Type-A / C



HL19

- Tilting switch
- Ergonomic design



HL36

- 2 Memory position
- OLED height display
- Lock



C51

- Wireless
- Build in battery
- Bluetooth connection
- Height display
- 2 Memory position



DP001

- Height range:245-460mm
- Width range:85-175mm
- Max. load:15kg



DP002

- Height range:260-505mm
- Width range:150-270mm
- Max. load:15kg



DP006

- Length range:380-530mm
- Width range:150-240mm
- Height range:300-530mm
- Max. load:15kg



DP007-1

- Length:250mm
- Width:195mm
- Max. load:10kg



DP003

- Length:460mm
- Width range:180-240mm
- Max. load:15kg



DP004

- Length:630mm
- Width range:230-340mm
- Max. load:15kg



DP007-2

- Length:290mm
- Width:275mm
- Max. load:10kg